



# Rollerdor RD77

## Installation Guide

Edition 2022/01



---

## CONTENTS

<b>02</b>	CHECKLIST & COMPONENTS
<b>04</b>	1. PREPARING SITE FOR INSTALLATION
<b>05</b>	2. HEADER ASSEMBLY CONSTRUCTION
<b>07</b>	3. PREPARING GUIDE RUNNERS FOR INSTALLATION
<b>09</b>	4. INSTALLING HEADER ASSEMBLY
<b>10</b>	5. INSTALLING CONTROL SYSTEM
<b>11</b>	6. INSTALLING CURTAIN TO BARREL (CURTAIN ROLLED SO BASE RAIL IS SEEN)
<b>13</b>	7. INSTALLING CURTAIN TO BARREL (CURTAIN ROLLED SO TOP RAIL IS SEEN)
<b>15</b>	8. SETTING MOTOR LIMITS (STANDARD MOTOR)
<b>17</b>	9. SETTING MOTOR LIMITS (SOMFY MOTOR)
<b>19</b>	10. INSTALLATION OF BACK CASE
<b>20</b>	11. OPTIONAL EXTRAS
<b>24</b>	12. TROUBLESHOOTING

# CHECKLIST & COMPONENTS

## EQUIPMENT REQUIRED

- 2 x Step ladders or hop ups
- Spirit level
- Tape measure
- Power drill
- 10mm A/F Spanner
- Pozi- screwdriver or drive bits
- 4mm, 7mm and 10mm Metal drill bit
- 7mm Masonry drill bit
- Hacksaw
- Small electrical screwdriver
- 4mm A/F Allen key
- Permanent Marker Pen
- Silicone Gun
- Silicone Sealer
- Rivet Gun
- 4mm Rivets

## ROLLERDOR COMPONENT CHECKLIST

- Door Curtain: consisting of slats, endlocks and base rail with rubber (safety edge will be on base rail if purchased).
- Barrel Assembly: made up of barrel with motor in one end, tube end, locking straps, collars (2 per strap) & cover slips (1 per strap).
- Full box housing: made up of front (L shape) and rear (C shape) case.
- Header plate: with 4 screws and roller guide attached.
- Header plate: with safety brake and roller guide attached.
- One Pair of Guide Runners.
- Winding handle with stem or external override system.
- Control System.
- Fixings Kit (Qty 10: 5 x 50 screws 7mm brown rawl plugs, plastic caps and Qty 1 plastic adjustment wand). **Please note: fixings supplied work on the majority of materials but if you know that you require specialised fixing please replace with these.**

## DOOR OVERVIEW

Please check all components for any visible damage, if there is any please contact your supplier.

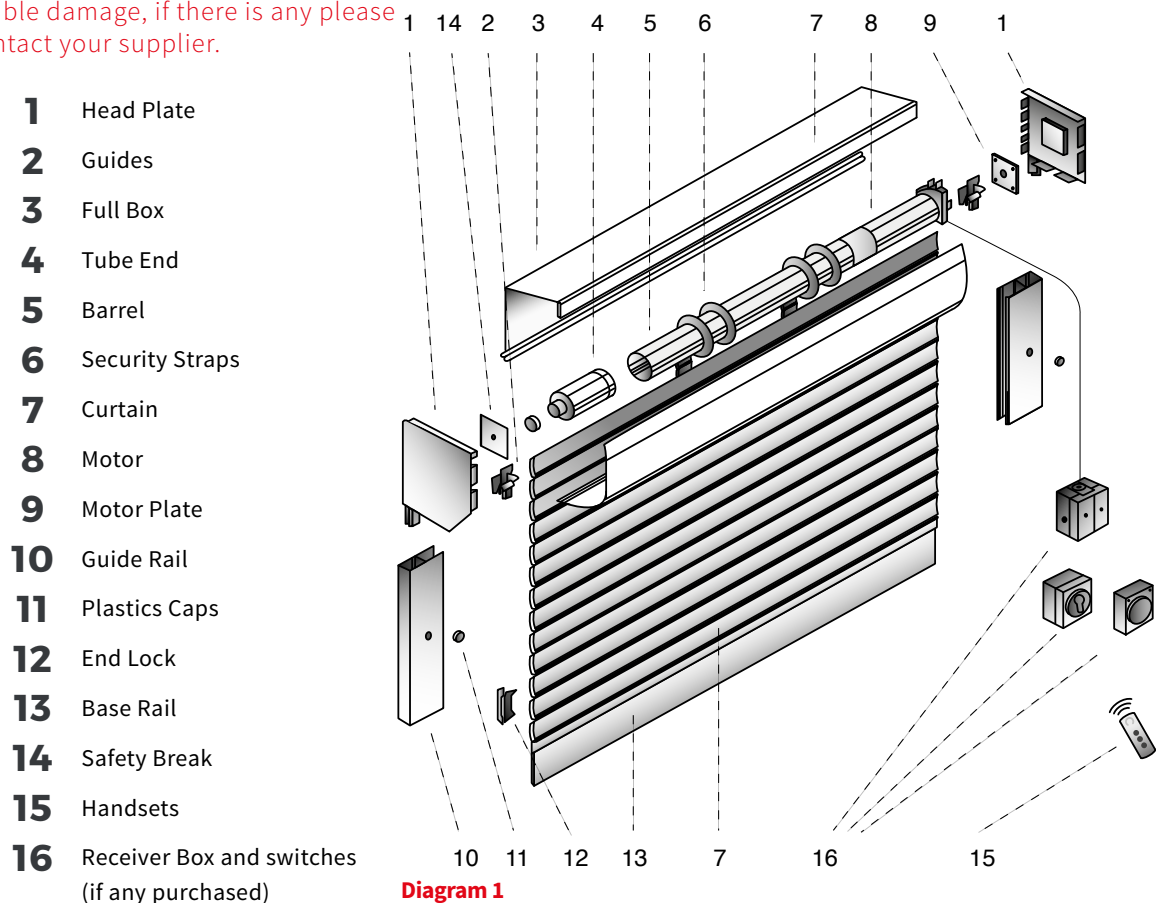



---

**These fitting instructions are for guidance only, you should always assess your building construction for installation as each opening has its own specific needs.**

**Please read these instructions carefully and in full before commencing the installation of your RD77 product.**

## **IMPORTANT SAFETY INSTRUCTIONS**

**The RD77 must be installed and operated in accordance with the instructions supplied; failure to do so could result in damage to your door and compromise your safety.**



## **WARNING AND GUIDANCE NOTES**

- 1** At least TWO people are required to install this product.
- 2** Prior to installing please remove all rings, watches and sharp objects to avoid any possibility of damage.
- 3** Prior to installing please remove any items of loose clothing to avoid any risk of entanglement or injury.
- 4** Your RD77 comes complete with a 3 pin plug as standard (this is supplied and must be fitted with a 13amp fuse) which should be plugged straight into a 13amp 3 pin switched socket in the vicinity of your control box. Should you need any extra electrical work, this must be carried out by a suitably qualified person. If you have any doubts please consult an electrician.
- 5** Your control system should be installed in a location that is at a comfortable height to operate, but out of the easy reach of children.
- 6** Please do not allow children to operate the RD77 as serious injury can occur from misuse.
- 7** Warning: you must have a clear line of sight of the whole of your curtain when it is in operation. Failure to do so may result in harm to persons or damage.

# 1. PREPARING SITE FOR INSTALLATION

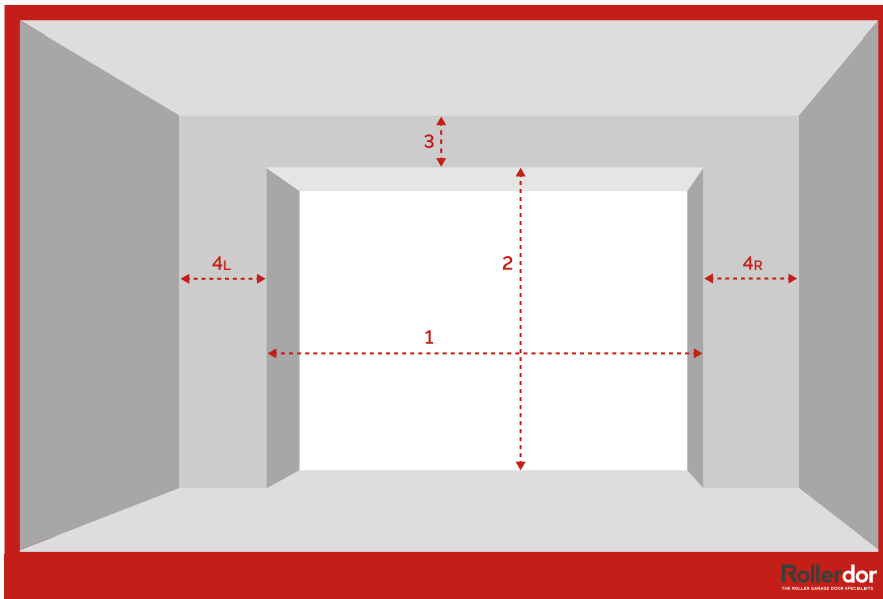

fig.1.1

- 1 Opening Width \_\_\_\_\_ mm
- 2 Opening Height \_\_\_\_\_ mm
- 3 Headroom Height \_\_\_\_\_ mm
- 4L Side Room \_\_\_\_\_ mm
- 4R Side Room \_\_\_\_\_ mm

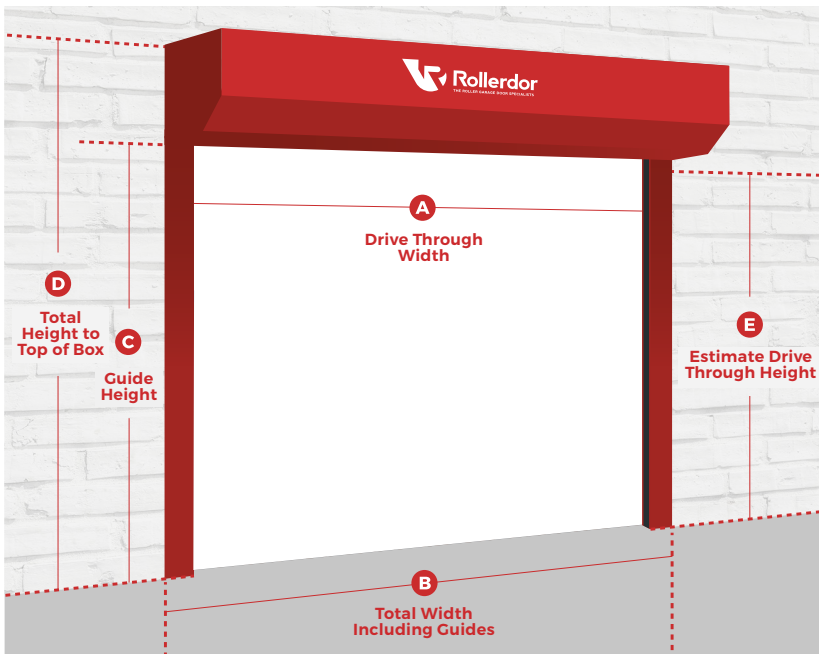

fig.1.2

- 1 Check all measurements of your opening (**fig.1.1**) as well as the measurements of your new delivered RD77 against your confirmation (**fig.1.2**) to make sure everything is correct.
- 2 Carefully remove any, frames, doors, shutters or anything else as required, so that you are left with a clear opening to work with.
- 3 Sweep down the sides and lintel with a stiff brush and clear all debris.
- 4 Make sure the opening is free from any raised metal or brick work.



## 2. HEADER ASSEMBLY CONSTRUCTION

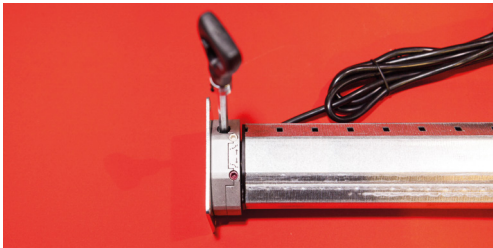

fig.2.1

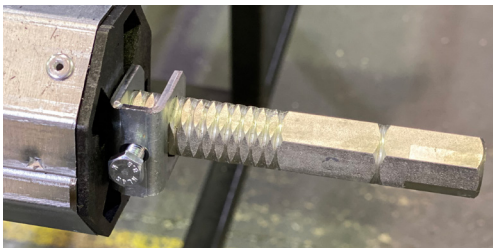

fig.2.2



fig.2.3



fig.2.4

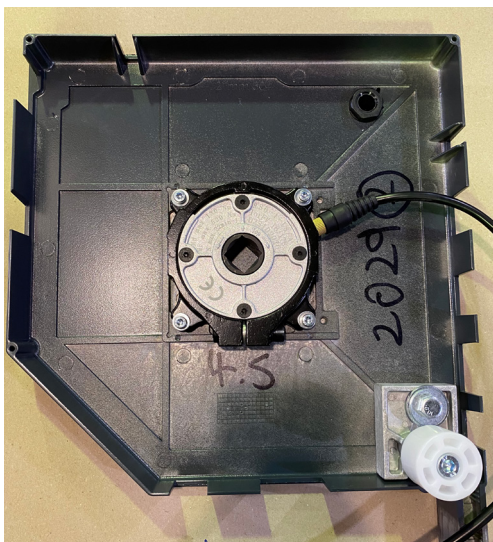

fig.2.5

- 1 On unpacking your RD77 kit you will see that the barrel has the motor in 1 end (**fig.2.1**) and the adjustable bung end the other (**fig.2.2**).
- 2 If your header plates have come separate from the casing please drill though the 'L' shaped front case and the flange on the header plate at each end, then secure 'L' shaped front case to the flange with at least 4 rivets (2 per face) (**fig.2.3**).
- 3 Remove screws from header plate (**fig.2.4**) and keep them safe for later.
- 4 **Round shape safety brake (fig.2.5)**: Loosen screw at the end of adjustable bung end to allow it to slide. Check the position of the safety brake to make sure that the big silver allen key bolt is running parallel to the shortest edge near the inlet wheel as in (**fig 2.5**). **Square shape safety brake (fig.2.6)**: Make sure the cable is coming out of the top of the safety break in line with the long flat side and the red curve on the safety break (**fig.2.10**) is going from fat to thin towards the front case. Loosen screw at the end of adjustable bung end to allow it to slide.
- 5 **(For IMO system)** remove winding stem from your winding handle where it has been taped securely (**fig.2.8.IMO**). **(For EMO system)** remove metal shaft via the plastic circllet (**fig.2.9.EMO**).
- 6 With the top case sitting flat & the locating stem facing up (**fig.2.3**), insert the barrel into the case, whilst one person holds the motor end extend the adjustable tube end so it goes into the safety brake as far as possible. **Round safety break (fig.2.11)** **Square safety break (fig.2.12)**.

**7** Remove the screw from the end of the winding stem and keep safe for later, insert the stem into the head of the motor, then rotate so the motor can be secured with the 4 screws onto the header plate through the 100x100 metal plate, making sure that the motor wire is facing down towards the case (**fig.2.7**), remove the winding stem and keep safe for later.

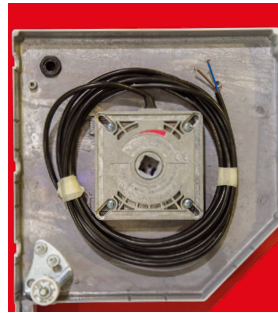

fig.2.6

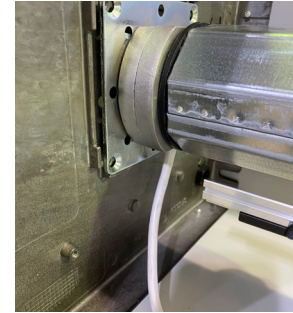

fig.2.7

**8** There is a cable coming from the brake, this may vary in length and depending on your width of opening a extension cable may need to be added, if so connect as follows; **Brown to Brown and Blue to Blue.**



fig.2.8.IMO



fig.2.9.EMO

**9** Place the plastic wand from your fixing kit into the hole in the head of the motor so it sticks up past the flange of the header plate, then using this as a guide drill a 10mm hole through the middle of the flange for the winding stem so it lines up with the hole in the motor, then insert the winding stem through the hole and back into the motor before securing in place with the screw. Please check the barrel is all the way to the motor head as (**fig.2.7**). Then check the opposite end where the tube end is and if fully extended, slide the locking collar all the way up to the bung and tighten into place (we advise using a thread lock adhesive to hold in place) as (**fig.2.11**) or (**fig.2.12**).

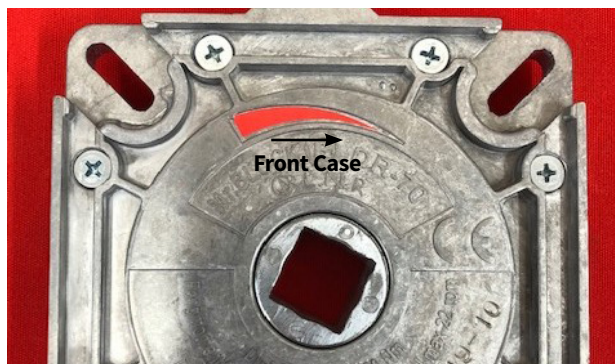

fig.2.10

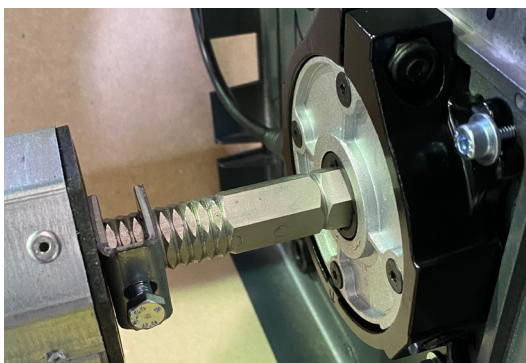

fig.2.11

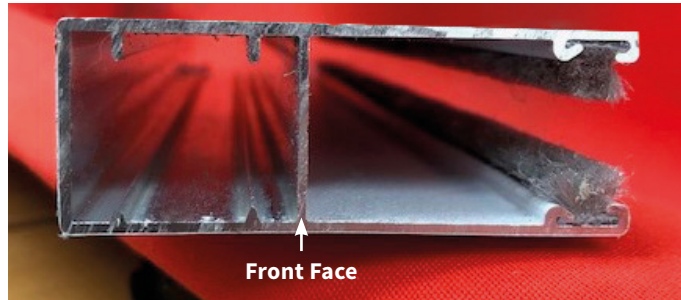

fig.2.12



### 3. PREPARING GUIDE RUNNERS FOR INSTALLATION

**1** We use 2 types of guide runners whichever is supplied with your kit will be marked with the letter 'F' to indicate the front, as seen in **(fig.3.1 type 1)** and **(fig.3.1 type 2)**. This marked face will fit against the wall for a standard back fixing or face out of the opening for a between fixing **(fig.3.5)**.



**(fig.3.1 type 1)**

**2** Your guide runners are supplied oversize and need to be CUT down to size, check the lintel is level then measure from floor to lintel both sides before referring to **(fig3.6)** and making the cuts as necessary (for best results, install the guide runners so that the cut end is against the floor).



**(fig.3.1 type 2)**

**3** Offer both cut guide runners up against the walls they will be fixed to and mark the fixing points, either on the flat face for a behind fixing **(fig.3.3)** or for a between fixing in the opening **(fig.3.4)**. For best results these should be as follows;

**A** Top fixing between 50mm to 100mm down from the top of the guide rail.

**B** Bottom fixing 50mm to 100mm up from the floor.

**C** Marking as many fixings as necessary but must be at least two extra fixings. Spread these evenly between the two already marked points on the guide runners so that you have a secure fix.

**D** Drill a 7mm hole all the way through each of the marks and then drill a 10mm hole to countersink through the first layer only so you can get the screw head through.



**fig.3.2**



**fig.3.3**

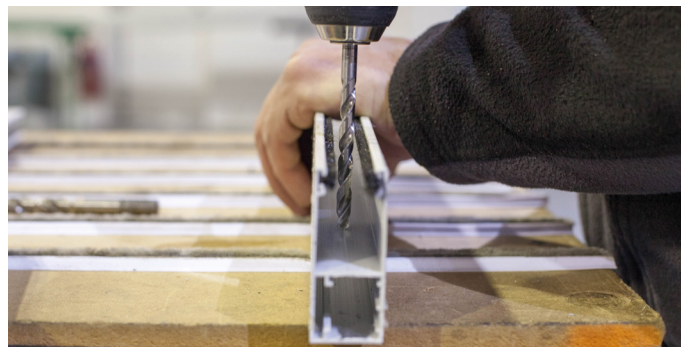

**fig.3.4**



**Fig.3.5**

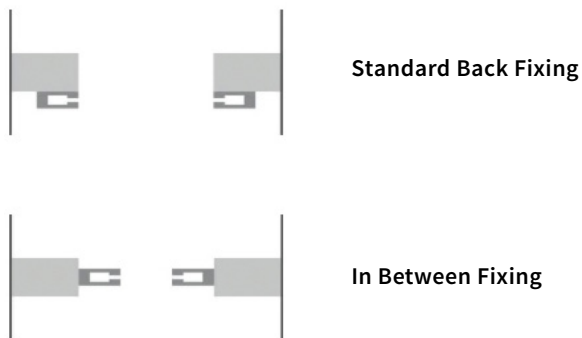

## FIXING OPTIONS

### Below Lintel Fixing:

Cut guide runners to measured height less 310 mm.

### Limited Opening Fixing:

Measure from floor to highest point, deduct 310 mm and cut guide runners to size.

### Behind Lintel Fixing:

Cut guide runners to measured height.

**Fig.3.6**

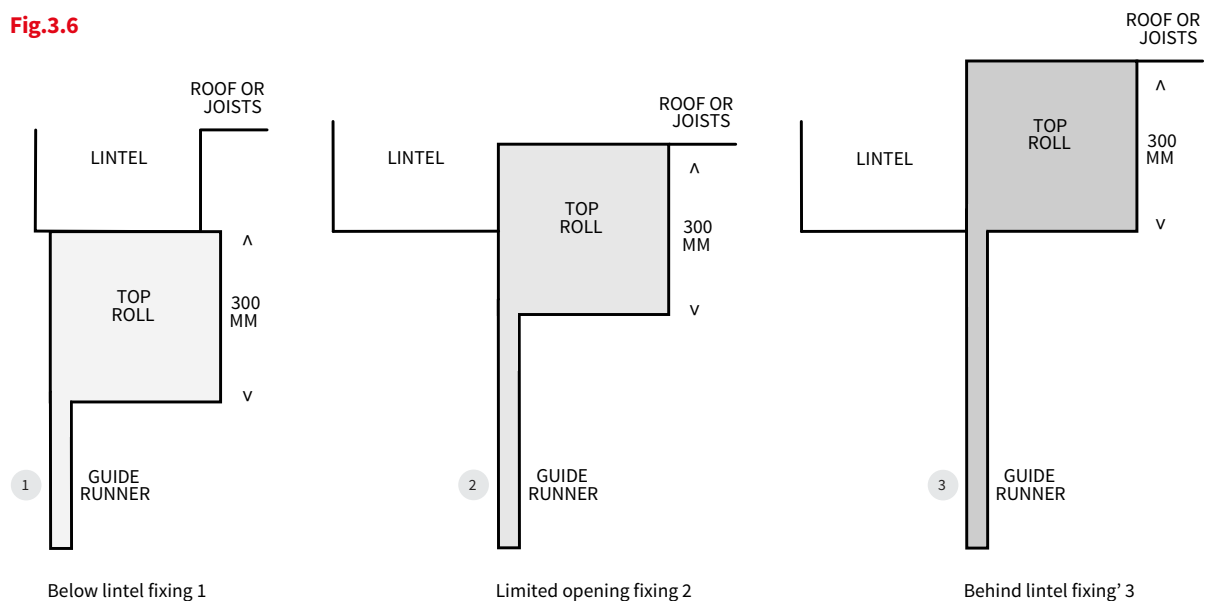



## 4. INSTALLING HEADER ASSEMBLY

- 1** Place your hop ups / step ladders and one guide runner each side of the opening.
- 2** With one person each end, lift the header assembly by the header plate up and then guide the locating stem at each end into the hollow section of guide runners. If there is not enough room to simply drop the locating stem in, you can angle the header plate (**fig.4.1**). Make sure to insert the stem fully into the guide runner (**fig.4.2**).
- 3** Lift the whole unit flush into place and check that the top box and guide runners are plumb, level and square.
- 4** Drill your fixing through the top hole in the guide runners and secure into place (**fig.4.3**).
- 5** Check the case and guide runners are still level and square, then proceed to drill your remaining fixings, remembering to check the guide runners are square and plumb after each fixing.
- 6** Once the guide runners are fixed you will need to secure the top box with 2 fixings each side. This is best done by drilling through the end flanges of the header plate for a behind fix, or sideways through the header plate itself if a between fixing (**fig.4.4**), PLEASE NOTE: The large cut outs in header plate are only for use with larger fixings e.g. shield anchor or coach screw.
- 7** Check to make sure all fixings have not caused the front fascia to be pulled in, as this will rub against the slats causing damage and scratching to the face.

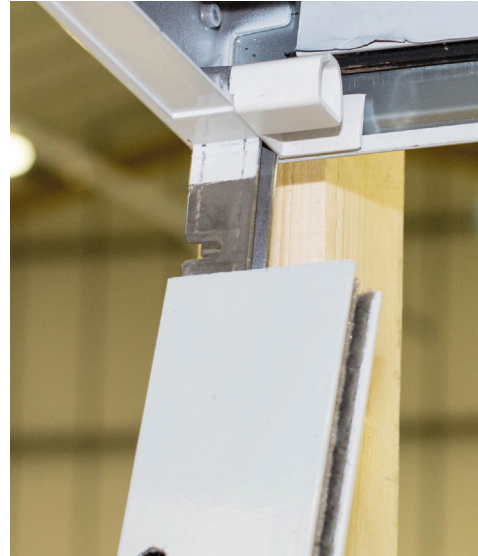

fig.4.1

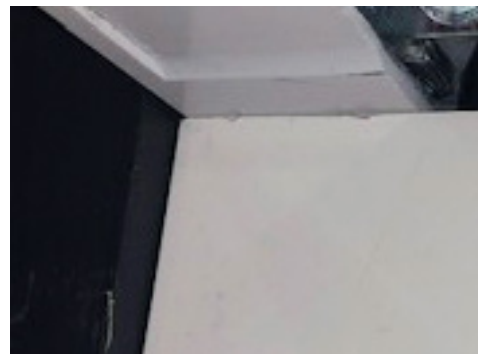

fig.4.2



fig.4.3

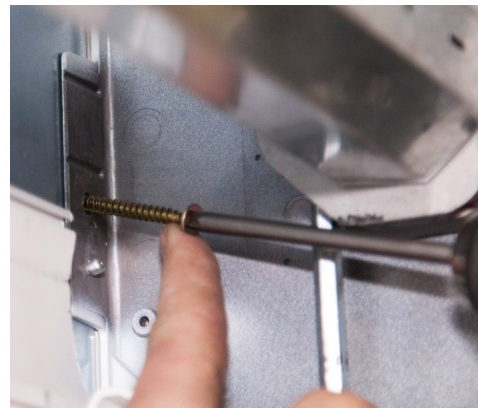

fig.4.4

## 5. INSTALLING CONTROL SYSTEM

We supply a varied range of control systems and each one has it's own installation instructions. On the box your control system came in should be the part number of the system and a QR code for you to scan to take you straight to the instructions you require from our website.

Alternatively please find below links for every control system we do, clicking on the link for the system you have on your computer, smart phone or tablet will take you straight to the page on our site where you can find the instructions, or you can type the link straight into your internet browser.



<https://rollerdor.net/wp-content/uploads/2022/01/Installation-Guide-RD3X2A-Control-Box-Type-2.pdf>



<https://rollerdor.net/wp-content/uploads/2022/01/RD10X2ELL-Control-Box-Type-9.pdf>



<https://rollerdor.net/wp-content/uploads/2022/01/Installation-Guide-RD3X2B-Control-Box-Type-2.pdf>



<https://rollerdor.net/wp-content/uploads/2022/01/RD20X2ELL-Control-Box-Type-8.pdf>



<https://rollerdor.net/wp-content/uploads/2022/01/RD20X2SOM-Somfy-Rollixo-Control-Box-Type-6.pdf>



<https://rollerdor.net/wp-content/uploads/2022/01/Installation-Guide-RD20X2ANSA-Control-Box-Type-7.pdf>

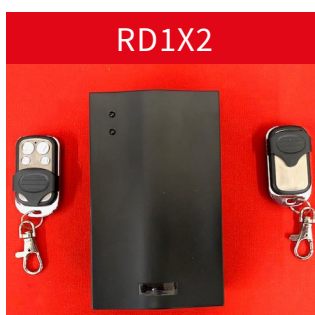

<https://rollerdor.net/wp-content/uploads/2022/01/Installation-Guide-RD1X2-Control-Box-Type-3.pdf>



## 6. INSTALLING CURTAIN TO BARREL

(CURTAIN ROLLED SO BASE RAIL IS SEEN)

- 1** Your locking straps will come attached to the barrel in no particular place or direction as this is dictated on installation (**fig.6.1**).
- 2** Remove all straps from barrel by removing the screws from the left collars of every pair and keeping safe for later, then slide the left collar across far enough so you have room to remove the straps (**fig.6.2**), remove straps and leave in a safe place then remove all screws from the right collars and keep safe for later.
- 3** Press and hold the down button until the barrel stops on its own, this will be the bottom limit. Using the manual override handle, wind the barrel so it rotates in the closing direction until you have clear access to the screw holes (**fig.6.3**).
- 4** Measure 250mm from the head of the motor and mark the barrel with a pen, measure 250mm from the safety brake and mark barrel with a pen, then measure to the middle of the door and mark barrel with a pen.
- 5** Attached to the barrel are the White plastic covers, you have 1 strap and 1 cover per pair of collars (**fig.6.4**).
- 6** Slide the nearest ring to the end of the barrel to line up with your marks and secure in place with provided screw, then slide the other ring from the pair over to this one leaving enough room to be able to get the strap in (**fig.6.3**). Spread the remaining pairs of rings out evenly across the barrel, if there is an odd number of pairs of rings make sure the middle pair of rings are one either side of the center mark.
- 7** Place a tool box into the opening for the curtain to sit on to, we recommend placing something soft onto the barrel for this stage to reduce damage to the back of the curtain. with 1 person each side lift the curtain up and carefully feed it over the barrel into the guides (**fig.6.5**) lowering all the way down so it sits on the tool box.
- 8** Slide the locking straps on to the top slat of the curtain trying to make sure they line up with the pairs of collars you have laid out.

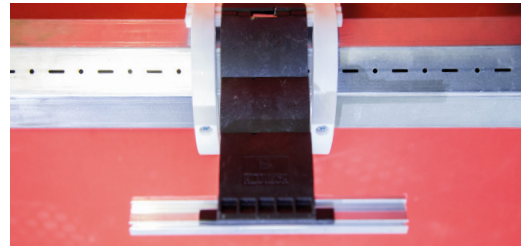

fig.6.1

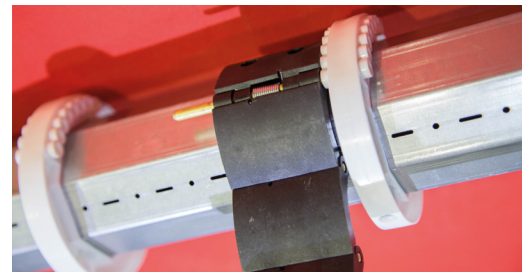

fig.6.2



fig.6.3

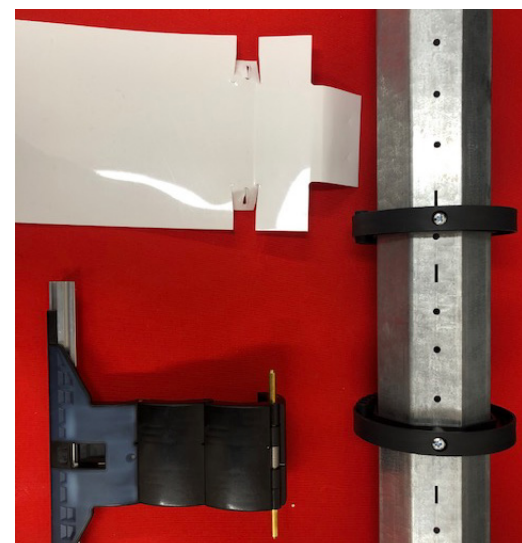

fig.6.4

## 9 Reattach the straps to the barrel;

The plastic covers are provided to add extra protection against marking to the back of the curtain as the roller door will be rolling on itself, sometimes this can cause marking on the back of the slats. You Do Not have to install these but we would advise you do. The covers are installed on the locking strap as in (fig.6.6). Secure each strap into a pair of collars by lining up the metal pin with the hole nearest you and sliding it into the collar (fig.6.7) then slide the second collar over so the metal pin goes into the hole leaving a rough 2mm gap either side (fig.6.8), then secure both collars in place with original screws.



fig.6.5

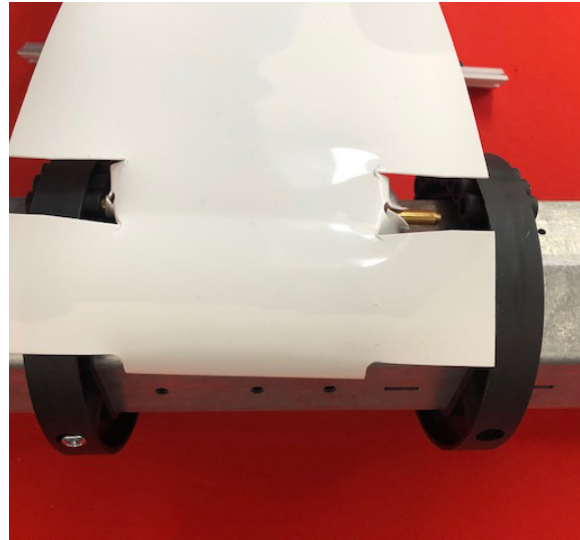

fig.6.7

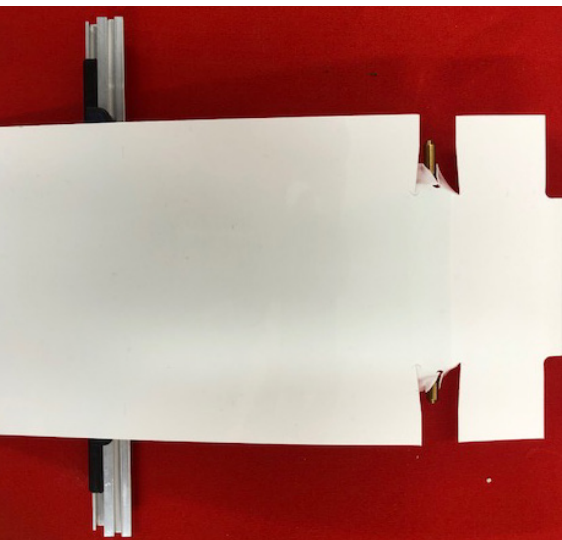

fig.6.6

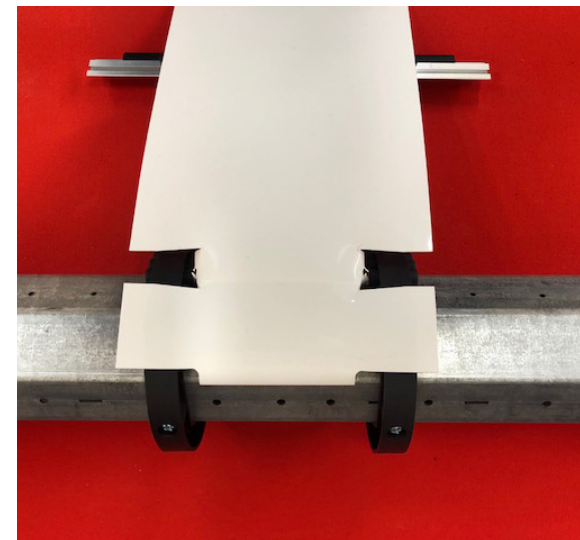

fig.6.8



## 7. INSTALLING CURTAIN TO BARREL (CURTAIN ROLLED SO TOP SLAT IS SEEN)

- 1** Your locking straps will come attached to the barrel in no particular place or direction as this is dictated on installation (**fig.7.2**).
- 2** Remove all straps from barrel by removing the screws from the left collars of every pair and keeping safe for later, then slide the left collar across far enough so you have room to remove the straps (**fig.7.3**), remove straps and leave in a safe place then remove all screws from the right collars and keep safe for later.
- 3** Press and hold the down button until the barrel stops on its own, this will be the bottom limit. Using the manual override handle, wind the barrel so it rotates in the closing direction until you have clear access to the screw holes (**fig.7.4**).
- 4** Measure 250mm from the head of the motor and mark the barrel with a pen, measure 250mm from the safety brake and mark barrel with a pen, then measure to the middle of the door and mark barrel with a pen.
- 5** Attached to the barrel are the White plastic covers, you have 1 strap and 1 cover per pair of collars (**fig.7.5**).
- 6** Slide the nearest ring to the end of the barrel to line up with your marks and secure in place with provided screw, then slide the other ring from the pair over to this one leaving enough room to be able to get the strap in (**fig.7.4**). Spread the remaining pairs of rings out evenly across the barrel, if there is an odd number of pairs of rings make sure the middle pair of rings are one either side of the center mark.
- 7** Slide the locking straps on to the top slat of the curtain trying to make sure they line up with the pairs of collars you have laid out. The plastic covers are provided to add extra protection against marking to the back of the curtain as the roller door will be rolling on itself, sometimes this can cause marking on the back of the slats. You Do Not have to install these but we would advise you do. The covers are installed on the locking strap as in (**fig.7.6**).

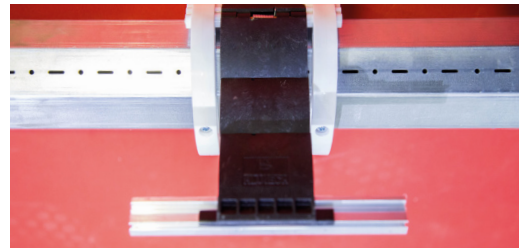

fig.7.2

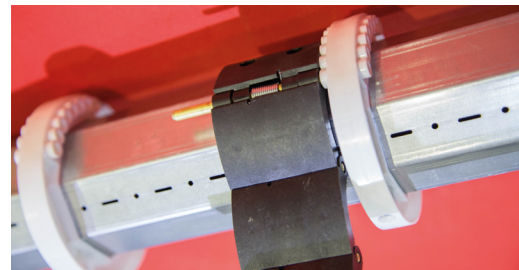

fig.7.3



fig.7.4

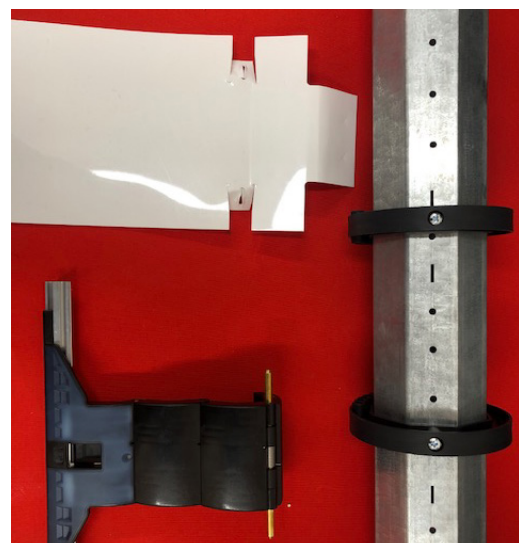

fig.7.5

- 8 Installing curtain and Reattach the straps to the barrel;** Move a pair of hop ups to each end making sure you have another room to easily lift the curtain to meet the barrel, with 1 person each end lift the curtain up to the barrel and secure the end straps into a pair of collars by lining up the metal pin with the hole nearest you and sliding it into the collar (**fig.7.7**), then slide the second collar over so the metal pin goes into the hole leaving a rough 2mm gap either side (**fig.7.8**).
- 9 Carefully** Step down from the hop ups and as you do let the curtain partially unroll in your arms, let the straps take the majority of the weight so 1 person can move to the middle of the curtain and hold the remaining weight of the curtain. The other person will use the hop ups to move to each pair of collars and attach them as in section 8 but this time securing all collars with the original screws provided including the first 2 straps installed in section 8.

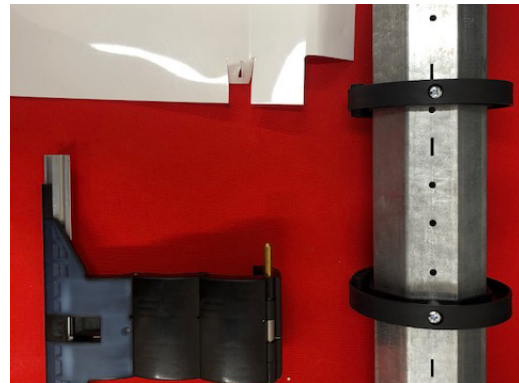

fig.7.5



fig.7.6

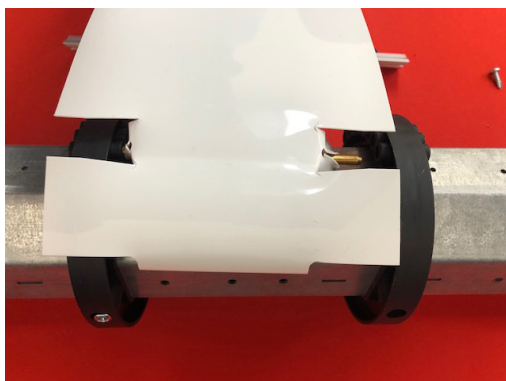

fig.7.7

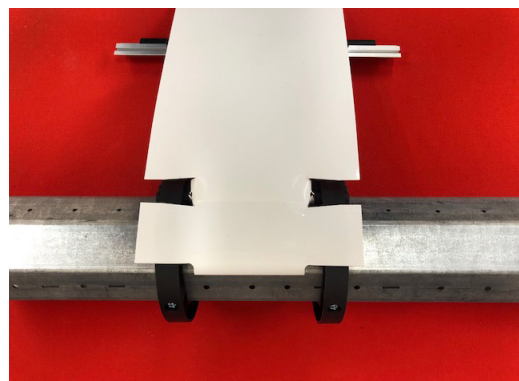

fig.7.8



## 8. SETTING MOTOR LIMITS

(STANDARD MOTOR)

- 1** **Curtain already in guides:** Press and hold the up button on receiver box so the curtain starts to roll up around the barrel, keep going until the motor stops or press the stop button if you get to 300mm (roughly 4 slats) from the top, then remove item from opening that was used to sit the curtain on.

**Curtain in arms:** Press and hold the up button on receiver box so the curtain starts to roll up around the barrel, Making sure to check the curtain rolls up away from the guide runners, the person with the curtain in their arms needs to let the door unroll and make sure it doesn't drop when you get to the last slats, keep going until the motor stops or press the stop button if you get to 300mm (roughly 4 slats) from the top, then use the manual winder to wind the curtain the last bit until it has passed the guides. Once it has passed the guides, wind the door back down so 4 slats are in the guides.

- 2** There are 2 straight line arrows on the head of the motor, these are to show you the direction that the limit nearest to it controls, place the plastic wand in to the limit with the arrow pointing towards the front case (**fig.8.1 & fig.8.2**) and turn 10 times in the negative direction, negative (-) and positive (+) are marked on the head of the motor and are the same direction for both limits.
- 3** Press and hold the up button and the curtain will travel to the top and should stop on its own, if the curtain gets to 100mm from the top of guide runners (roughly 2 slats) and hasn't stopped, then stop the curtain and take it back down to 300mm from top of guides (roughly 4 slats) turn again 15 times in the negative direction, take the curtain up and repeat until the curtain does stop before it gets to 100mm from top.
- 4** **For Somfy Rollixo ONLY:** Turn the limit towards the positive direction (+) and after each couple of turns, use the buttons on the control box to close the curtain slightly before opening it again each time moving a little higher. Keep doing this until there is one full slat in the guide runners. Take the curtain down a little and back up to make sure you are happy.

**For every other control system:** Whilst holding the up button turn the wand in the positive direction and the curtain will start to judder up, keep going until there is only the last slat in the guides. Take the curtain down a little and back up to make sure you are happy.



fig.8.1

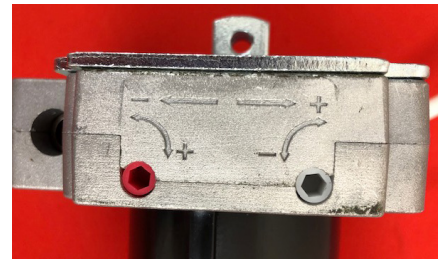

fig.8.2



fig.8.3



- 5** Move the plastic wand in to the other limit with the arrow pointing towards you and turn 10 times in the negative direction.
- 6** Press and hold the down button so the curtain closes, it should stop before it touches the floor if this is not the case take the curtain back up 300mm off the floor and turn again 15 times in the negative direction, take the curtain back down and repeat until the curtain does stop before it reaches the floor.
- 7** **For Somfy Rollixio ONLY:** Turn the limit towards the positive (+) direction. After each couple of turns, open the curtain slightly and then close it each time closing a bit further.  
**For all other control systems:** Whilst holding the closed button on the handset turn the wand in the positive direction and the curtain will start to judder down.
- 8** Keep repeating until the curtain is fully compressed and pressure is applied from the top via the locking strap. The ideal finishing position of the curtain is to have the top of the guide runner exactly in the middle of the very top slat (**fig.8.4**) but no more than 1 full slat above the top of the guide runner (**fig.8.3**) if there is more than this you will need to remove the extra slats.
- 9** Close the curtain down to make sure it doesn't catch anywhere and the front case is not bowed in so as to rub on the curtain during operation, then seal down the sides and along the top case as needed (silicone sealant is recommended).

**fig.8.4**



## 9. SETTING MOTOR LIMITS

(SOMFY MOTOR)

- 1** Your somfy motor comes with a limit cap cover, remove and keep the cover safe for later (**fig.9.1 & 9.2**).
- 2** Using a screw driver press both limits all the way in so when you release they will click and hold in place (**fig.9.3**).
- 3** **Curtain already in guides:** Press and hold the up button on receiver box so the curtain starts to roll up around the barrel, keep going until there is 1 full slat left in the guide runner, then remove the tool box from opening that was used to sit the curtain on.  
  
**Curtain in arms:** Press and hold the up button on receiver box so the curtain starts to roll up around the barrel, Making sure to check the curtain rolls up away from the guide runners, the person with the curtain in their arms needs to let the curtain unroll and make sure it doesn't drop when you get to the last slats, keep going until the whole curtain is up passed the top of the guide. Once passed the guides, wind the curtain down so 2 slats are in the opening, then press and hold the up button on the receiver box again so the curtain goes up. Stop the curtain when 1 full slat is left in the guide runners.
- 4** Using a screw driver press in and release the coloured limit for the open / up direction as per diagram (**fig.9.5**).
- 5** Run the curtain down until fully compressed and pressure is applied from the top via the locking strap. The ideal finishing position of the curtain is to have the top of the guide runner exactly in the middle of the very top slat (**fig.9.6**) but no more than 1 full slat above the top of the guide runner (**fig.9.7**) if there is more than this you will need to remove the extra slats.
- 6** Using a screw driver press in and release the coloured limit for the close/down direction as per diagram (**fig.9.5**).
- 7** Run the curtain all the way to the top limit to check it stops in the correct position, then run the curtain all the way to the bottom limit to check it stops at the correct position and if happy, replace the cap to cover the limits (**fig.9.1**). If the limits are incorrect repeat procedure from start.
- 8** Close the curtain down to make sure it doesn't catch anywhere and the front case is not bowed in so as to rub on the curtain during operation, then seal down the sides and along the top case as needed (silicone sealant is recommended).



fig.9.1

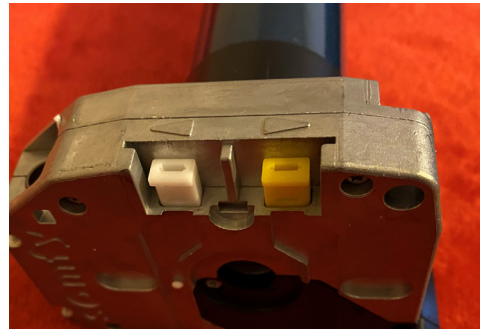

fig.9.2

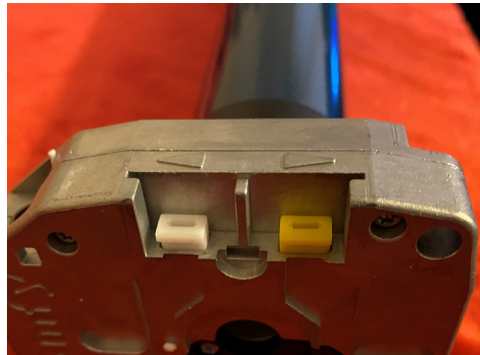

fig.9.3

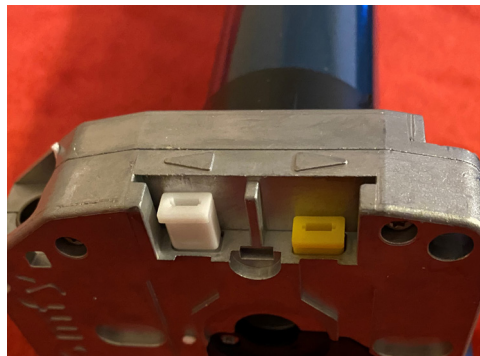

fig.9.4

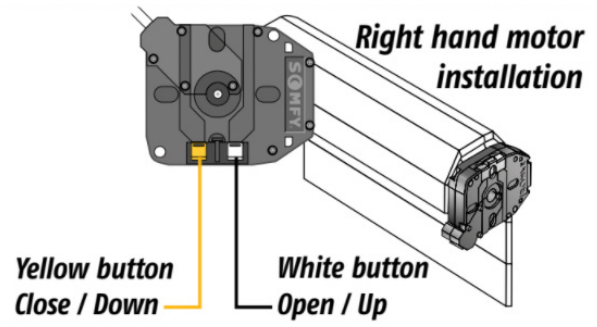
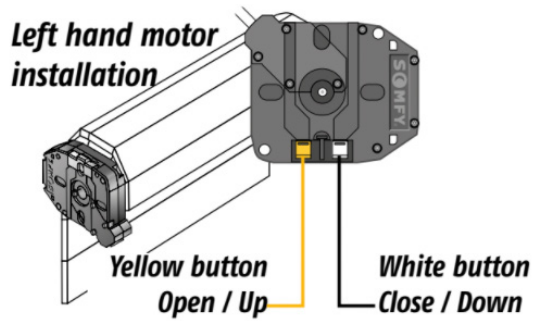

fig.9.5



fig.9.6



fig.9.7



## 10. INSTALLATION OF BACK CASE

- 1** Lift the back case to offer up into place and mark for winding stem and if needed the wire gland (**fig.10.1**).
- 2** Take down and place on a flat surface (**fig.10.2**), then cut out the slots needed (**fig.10.3**).
- 3** Clean up any loose or rough edges (**fig.10.4**).
- 4** Lift the back case up as close to the winding stem and gland as possible, hook the back case into the top lip where the two cases meet (**fig.10.5**) and slide across to go all the way to the edge of the header plate, making sure when it is all the way over that the whole of the two cases are slotted together.
- 5** With the self-tapping screw provided, secure through the back case into the bottom flange of the header plate on both sides (**fig.10.6**).



fig.10.1



fig.10.2



fig.10.3



fig.10.4

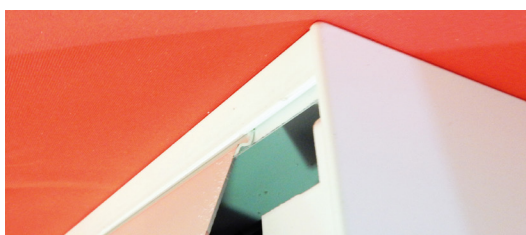

fig.10.5

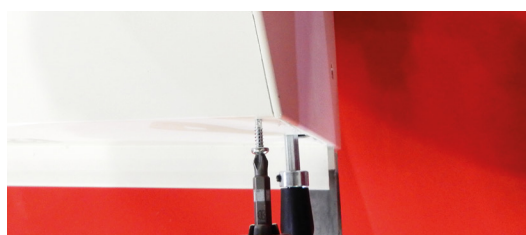

fig.10.6



Completed

# 11. OPTIONAL EXTRAS - INSTALLATION RDEORM EXTERNAL OVERRIDE KIT

- 1** Mark the height you require your external override to go through the wall and drill a 25mm hole through the wall all the way.
- 2** Place the longer thinner plastic tube into the hole so the end is flush with the front of the brick work (**fig.11.1**) the rest of the tube will be inside the garage (**fig.11.2**) mark tube where the wall line is and then cut the tube to size.
- 3** Detach the universal joint from the long internal arm by removing the pin and keep the pin safe for later (**fig.11.3**).
- 4** Use a 2mm allen key to remove all 4 grub screws from the cylindrical attachment and remove from bar (**fig.11.5 & fig.11.6**). Measure the length of the plastic tube and cut the bar from the universal joint (**fig.11.4**) so it is 120mm shorter than this measurement, then slide the cylindrical attachment back on the bar but only 20mm before securing in place with 2 grub screws (**fig.11.6**) remaining 2 grub screws are not needed.
- 5** Insert the shaft all the way into the plastic tube, then insert the tube into the wall from the inside, the tube should be flush on the outside (**fig.11.7**), with the universal joint vertical, mark the 2 fixing points then drill and secure to the wall.
- 6** Your external fixing plate is universal with directions of rotation depending on what side your motor is on, it needs to be put together with the lock (**fig.11.8**).
- 7** To assemble the lock first place the flat washer onto the lock cylinder, then slide the faceplate on the correct way round (left hand motor = close on the left, right hand motor = close on the right), then place the indented washer on with the indents facing inwards followed by the locking nut and tighten (**fig.11.9**).



fig.11.1



fig.11.2



fig.11.3



fig.11.4



fig.11.5



fig.11.6



fig.11.7



fig.11.8



fig.11.9



fig.11.10

8 Take the lock and plate to the outside and place in plastic tube the correct way up (if the lock wont go all the way in so it is flush against the wall you may need to adjust the barrel or cylinder on the universal joint), mark the 4 fixing points before removing and drilling fixings, reinsert the locking plate and fix into position (fig.11.10).

9 Remove the plastic clip from the end of the long shaft (fig.11.11) this will release the shaft for the motor, remove the screw from the end of shaft and the support collar then insert the shaft into the top box, once past the header plate place the collar back on and then continue to insert the shaft into the motor, once all the way through re attach the screw in the end to hold in place (fig.11.12).

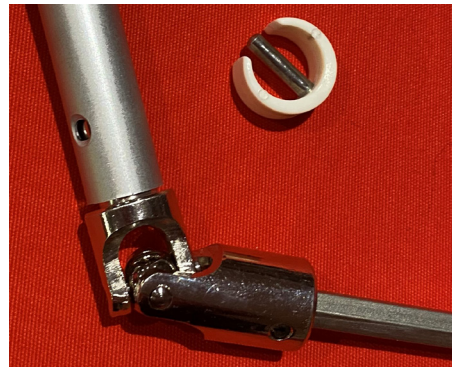

fig.11.11



fig.11.12

- 10** Reconnect the universal joint at the wall to the long shaft making sure it is straight (**fig.11.13**) then take it up to the joint as the motor shaft end, you can change the angle by adjusting the position of the collar inside the header box and securing in place (**fig.11.12**), once happy with the position, measure, mark and then cut the long shaft to size.
- 11** Drill a 5mm hole in the end of the long shaft in line with hole in the joint, slide the large short plastic tube over the end of the long shaft (**fig.11.14**) then slide the long shaft into the joint before reattach the plastic pic through hole (**fig.11.15**).
- 12** The External override kit is now installed (**fig.11.16**) remove the lock and test to make sure everything works as it should by inserting the handle into the cylinder head hole (**fig.11.17**) making sure the handle shaft lines up and seats all the way in before turning.
- 13** Lastly check the handle inside to make sure this works as well, slide the plastic cover on the long shaft (**fig.11.14**) up to reveal the handle (**fig.11.13**), remove the metal pin (**fig.11.3**) to release the handle, bend joints to make handle shape and test before reattaching.



fig.11.13



fig.11.14



fig.11.15



fig.11.17



fig.11.16



# OPTIONAL EXTRAS - INSTALLATION

## RDEOBP EXTERNAL OVERRIDE KIT

- 1** You're RDEOBP external override kit is made up of 3 parts (**fig.12.19**).
- 2** Mark the height you require your external override to go through the wall and drill a 22mm hole through the wall all the way.
- 3** Place the plastic tube into the hole from the front with the plate flush against the outside wall and mark the 4 holes for fixing the plate (**fig.12.20**).
- 4** Then go inside and mark the length to cut off the plastic insert (**fig.12.18**).
- 5** Remove from the wall, drill 4 fixings outside and cut plastic tube to size then reinsert in wall.
- 6** Insert universal joint at bottom of shaft into the plastic tube end and mark 2 fixing holes (**fig.12.21**).
- 7** Mark the length you need to cut the shaft to make fit with stem.
- 8** Cut shaft to size and drill a 5mm hole in the shaft so you can reapply clip to attach shaft to stem.
- 9** Drill fixing holes for universal joint.
- 10** Attach shaft to stem with clip and place universal joint into plastic tube and screw to wall (**fig.12.22**).
- 11** Remove lock and check to make sure the unit turns.

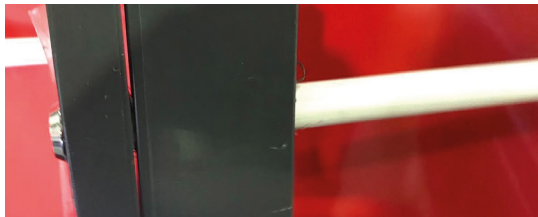

fig.12.18

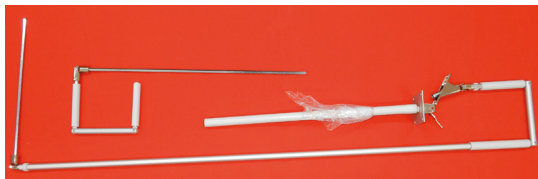

fig.12.19



fig.12.20



fig.12.21



fig.12.22



## 12. TROUBLESHOOTING

---

### Q.

I was setting the limits and it was all ok but it just stopped and will not move up or down electrically but I can still wind the door by hand.

### A.

The motor provided is a friction drive and as such will generate heat. If the curtain is open and closed a lot in succession (as it is on initial installation) the thermal cut out can kick in, if this happens turn the power off and wind the curtain down by hand so as to allow air to pass over the barrel and cool down, this can take in excess of 45 minutes.

---

### Q.

I have pressed the button on my handset and nothing is happening.

### A.

- 1 Does the red light come on when you press the button on the handset? If not then change the battery on the handset.
  - 2 Is the light on the receiver box on? If not then check the power supply to the control panel.
  - 3 Is a noise coming from the motor when you activate it? If so then check the security straps, if these are disconnected or broken you will need to contact the office to purchase some more.
  - 4 Can it be opened by using the manual winding handle? If so then can it be operated after winding? If this still doesn't work please contact your installer, as the safety brake may have engaged and could have damaged the switch. This will need to be re-engaged or, if broken, replaced.
- 

### Q.

Every time I press to close, the curtain moves and then it will reopen.

### A.

- 1 Check to make sure there are no obstructions in the way of the curtain and that the guide runners are clear of debris and have not been damaged or dented.
- 2 The safety edge can sometimes think that strong winds are an obstruction and as such will re-open. If this is the case, then activate the hold to run function on your handset or receiver box to close fully and then return to it another day to make sure it is working OK. If this keeps happening contact your installer as the sensitivity on your safety edge may need adjusting.



---

**Q.**

When closing it came into contact with an obstacle and I didn't stop in time, now it will not open.

**A.**

Check to make sure the security straps are ok and are not broken or out of shape. Can the straps bend back on themselves? If this is the case, you will need to contact the office to purchase some more.

---

**Q.**

When closing it came into contact with an obstacle and I pressed stop then pulled the obstacle out of the way but the curtain dropped and now it will not move.

**A.**

- 1** Can you open by using the winding handle? If so, then try the buttons on the box after winding, if the door still will not work then you will need to contact your installer as the safety brake on your door may have engaged and could have damaged the switch. This will need to be re-engaged or, if broken, replaced.
  - 2** If you can't wind the curtain up, check to make sure the security straps are ok and are not broken or out of shape. Can the straps bend back on themselves? If this is the case, you will need to contact the office to purchase some more.
- 

**Q.**

My receiver box keeps making a beeping noise when I use it.

**A.**

Check the batteries in your safety edge device as they may need replacing, make sure to replace them with a like for like battery and to check the polarity, until you have replacements the door can still be used on a hold to run function by pressing and holding the close button on the handset.

---

**Q.**

My curtain will open but when I try to close it will not move?

**A.**

- 1** Check the batteries in your safety edge device as they may need replacing, make sure to replace them with a like for like battery and to check the polarity, until you have replacements the door can still be used on a hold to run function by pressing and holding the close button on the handset.
- 2** Check the receiver box are there any warning lights or any audio beeps to highlight a problem, if so check the Installation instructions for your control system or contact your installer for advice.

Rollerdor Ltd  
10 & 12 Jarrold Way  
Bowthorpe Employment Area  
Norwich  
Norfolk NR5 9JD

**+44 (0)1603 743215**  
**sales@rollerdor.net**  
**www.rollerdor.net**

Company Registration Number. 10676267

Registered Office Address:  
Rollerdor Ltd, Bankside 300 Peachman Way,  
Broadland Business Park, Norwich,  
Norfolk, United Kingdom, NR7 0LB

Edition 2022/01

